

FAEBI®

Rubber air spring insulator

Highly effective insulation of vibrations, shocks and structure borne noise for machines, apparatus and aggregates.



FAEBI® RUBBER AIR SPRING INSULATOR

FAEBI® rubber air springs are used for the highly effective insulation of machines, apparatus and aggregates from shocks, vibrations and structure borne noise. The element comprises of a bell-shaped rubber form made from high-grade elastomer with a reinforced side wall. The constructive design does not only achieve excellent insulation properties, but also very high mechanical stability. Damage due to overload or a sudden pressure drop is virtually impossible. The air spring element has a very low degree of deflection in the horizontal direction. The inclusion of anti-slip pads on the spring element base plate means that additional floor anchoring is not usually required.

Note:

- FAEBI® elements can also be supplied in stainless steel designs and from EDPM elastomer for outdoor use (such as air conditioning).
- To reduce the movement amplitude in the vertical direction the FAEBI®-HD variant is supplied with additional damping.

Applications

Perfectly suited for source insulation of fast running presses, forging hammers and other machines and aggregates with highly dynamic disturbance forces. Passive insulation of measuring and test equipment as well as highly accurate machine tools. Can also be combined with mechanical level control on request.

SHOCK AND VIBRATION INSULATION

The natural frequency of the rubber air spring in the vertical direction is between 3 and 14 Hz depending on the allowable static load and variant. The maximum spring deflection in response to a pulse load is up to 15 mm depending on the type and size of the air spring.

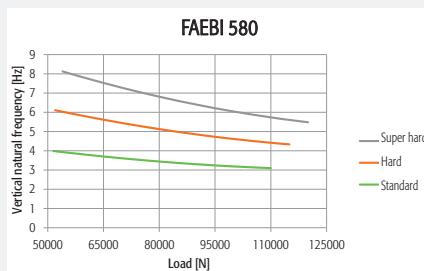
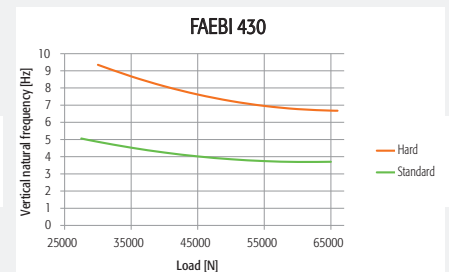
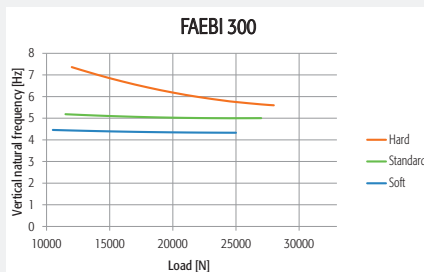
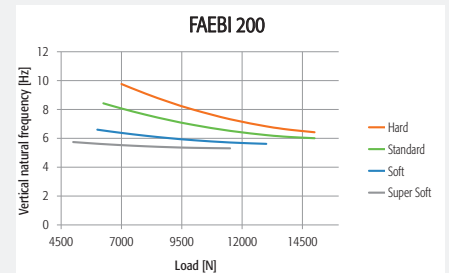
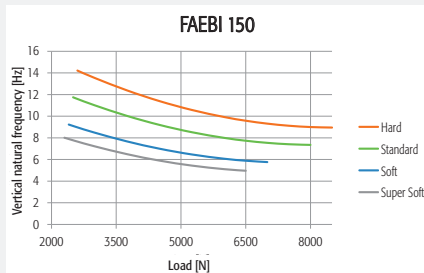
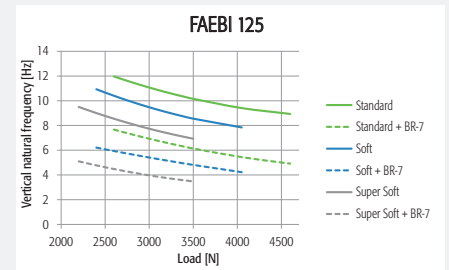
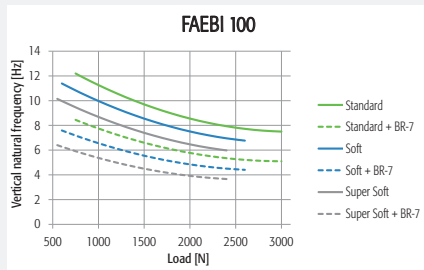
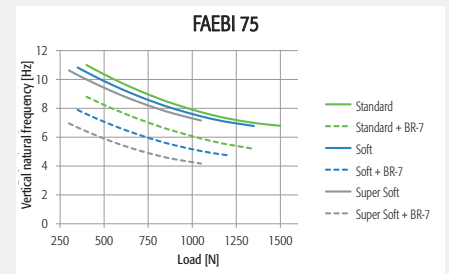
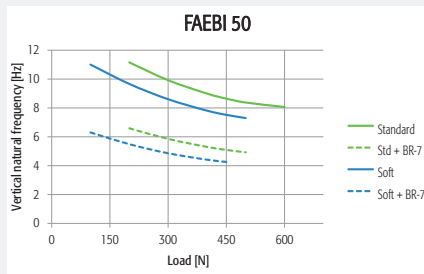

SERIES TYPE FAEBI®

Type	Variant	Item no. FAEBI®	Load N/pc.	max. Pressure bar	A mm	ØD mm	H approx. mm = Working height	H (deflated) mm	Ød mm	h mm	G mm
FAEBI® 50	Standard	40-0071	200–600	3	110	80	60	61	35	5	M10
	Standard + BR7-1	40-0134	200–500	2.5	110	80	62	68	35	5	M10
	Soft	40-0072	100–500	2.5	110	80	60	61	35	5	M10
	Soft + BR7-1	40-0135	100–450	2.3	110	80	62	68	35	5	M10
FAEBI® 75	Standard	40-0082	400–1.500	3	115	97	63	67	43	5	M12
	Standard + BR7-1	40-0136	400–1.350	2.7	115	97	65	74	43	5	M12
	Soft	40-0084	350–1.300	2.6	115	97	63	67	43	5	M12
	Soft + BR7-1	40-0137	350–1.200	2.4	115	97	65	74	43	5	M12
	Super Soft	40-0083	300–1.050	2.1	115	97	63	67	43	5	M12
	Super Soft + BR7-1	40-0138	300–1.050	2.1	115	97	65	74	43	5	M12
FAEBI® 100	Standard	40-0024	750–3.000	5	135	118	62	65	60	5	M12
	Standard + BR7-1	40-0139	750–3.000	5	135	118	64	72	60	5	M12
	Soft	40-0026	600–2.600	4.4	135	118	62	65	60	5	M12
	Soft + BR7-1	40-0140	600–2.600	4.4	135	118	64	72	60	5	M12
	Super Soft	40-0025	550–2.400	4	135	118	62	65	60	5	M12
	Super Soft + BR7-1	40-0141	550–2.400	4	135	118	64	72	60	5	M12
FAEBI® 125	Standard	40-0033	2.600–4.600	5.5	165	140	93	98	66	5	M16
	Standard + BR7-1	40-0142	2.600–4.600	5.5	165	140	95	105	66	5	M16
	Soft	40-0035	2.400–4.050	4.9	165	140	93	98	66	5	M16
	Soft + BR7-1	40-0143	2.400–4.050	4.9	165	140	95	105	66	5	M16
	Super Soft	40-0034	2.200–3.500	4.2	165	140	93	98	66	5	M16
	Super Soft + BR7-1	40-0144	2.200–3.500	4.2	165	140	95	105	66	5	M16
FAEBI® 150	Hart	40-0043	2.600–8.500	6.4	200	170	91	96	80	8	M16
	Standard	40-0037	2.500–8.000	6	200	170	91	96	80	8	M16
	Soft	40-0040	2.400–7.000	5.3	200	170	91	96	80	8	M16
	Super Soft	40-0038	2.300–6.500	4.9	200	170	91	96	80	8	M16
FAEBI® 200	Hart	40-0051	7.000–15.000	6	260	236	91	95	130	8	M16
	Standard	40-0046	6.250–15.000	6	260	236	91	95	130	8	M16
	Soft	40-0048	6.000–13.000	5.2	260	236	91	95	130	8	M16
	Super Soft	40-0047	5.500–11.500	4.6	260	236	91	95	130	8	M16
FAEBI® 300	Hart	40-0058	12.000–28.000	6.5	370	340	89	93	200	8	M20
	Standard	40-0055	11.500–27.000	6	370	340	89	93	200	8	M20
	Soft	40-0056	10.500–25.000	5.6	370	340	89	93	200	8	M20
FAEBI® 430	Hart	40-0065	30.000–66.000	6.1	500	480	89	94	315	8	M20
	Standard	40-0064	27.500–65.000	6	500	480	89	94	315	8	M20
FAEBI® 580	Super Hart	40-0079	54.000–120.000	6.6	680	650	89	91	380	14	M24
	Hart	40-0078	52.000–115.000	6.3	680	650	89	91	380	14	M24
	Standard	40-0076	51.500–110.000	6	680	650	89	91	380	14	M24

Note

- Ensure that the element is selected so that the maximum load (static and dynamic load) is not exceeded!
For applications with higher dynamics harder variants of the FAEBI® reduce the deflection of the element. However, the softer the element is, the better the achievable insulation effect is.
Please contact us, we are happy to assist with selecting a suitable element.
- If the bottom edge of the machine does not completely cover Ø d, we recommend the use of our special **protective hood** (see Accessories p. 46).
- Permissible temperature range: -20 °C to +80 °C
- The elements are attached to the holes provided on the machine using the bolts supplied (see Accessories p. 46).
Anchoring to the floor is usually not necessary.
- **Screw in the bolt by hand only, do not use a wrench. Also only tighten the nut with low torque.**
- The machine is placed on the deflated element, which is then inflated in stages using the standard valve until dimension H (= working height) is reached. The maximum specified air pressure must also not be exceeded!
- **Inflation and deflation may only take place under load (observe the maximum permissible pressure).**
- Up to +/- 5 mm are available for levelling.

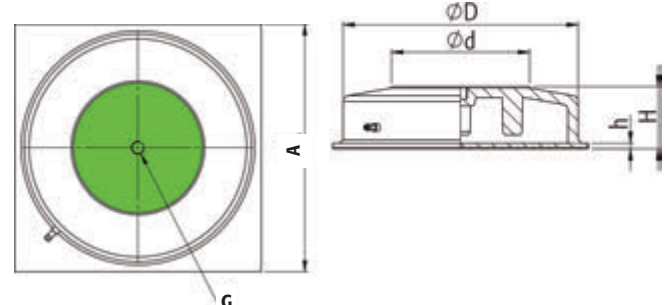

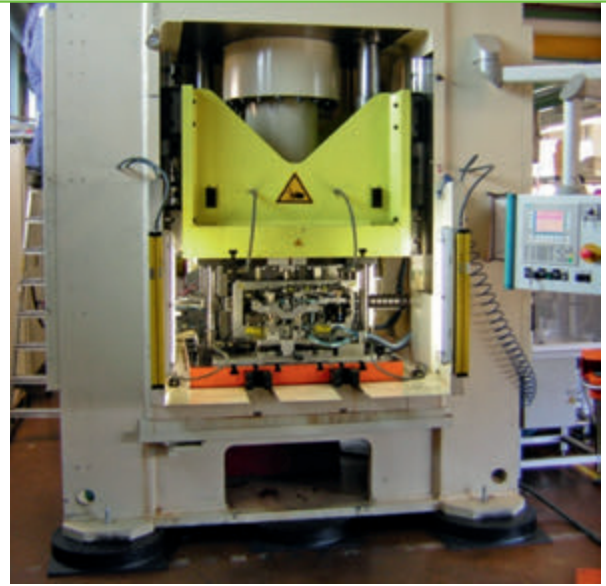

ADVANTAGES COMPARED TO STEEL SPRINGS

In comparison to steel springs the use of air spring offers many advantages when used for vibration insulation:

- Flexible insulation system design:
Changes in the static or dynamic loads can be compensated for by adjusting the air pressure. This can be performed either manually or pneumatically (e.g. using Bilz level control)
- Integrated damping, therefore separate damping is not necessary.
- No transmission of structure borne noise



FAEBI® in stainless steel and EPDM-version for outside applications

FAEBI® elements in VA and EPDM versions were specifically developed for outside applications. Effortless vibration insulation of systems in the open air such as air conditioning units, compressors, heat exchangers, cold water chillers.

Note:

- Permissible temperature range: -25 °C to +125 °C
- Prices and delivery times on request.
- In addition to our standard solutions listed here we also carry numerous special solutions. Please contact us, we would be happy to advise you.
- The use of a stainless steel protective hood is recommended for outside applications.





Type series **FAEBI®-HD** with adjustable damping

The combined rubber-air spring insulator FAEBI®-HD with adjustable damping comprises of an elastomer metal bonding with reinforced side wall and a two-chamber system.

To achieve the greatest possible damping effect the interior of the air spring is divided into two air chambers connected by an air hose (load and damping volume). An adjustable throttle valve is used to set the flow cross section to the desired damping effect from the outside. The significantly higher damping effect compared to a single chamber system (FAEBI®) reduces the resonance amplification substantially and the machine movements fade noticeably faster. The increased energy substantially absorption also has a positive effect on the manufactured goods and on machine and tool wear.

Benefits: In comparison to viscous damping air damping is absolutely free of wear and maintenance-free and the damping factor can be easily adjusted from outside.

Note

- Ensure that the element is selected so that the maximum load (static and dynamic load) is not exceeded! For applications with higher dynamics harder variants of the FAEBI® reduce the deflection of the element. However, the softer the element is, the better the achievable insulation effect is. Please contact us, we are happy to assist with selecting a suitable element.
- If the bottom edge of the machine does not completely cover $\varnothing d$, we recommend the use of our special **protective hood** (see Accessories p. 46).
- Permissible temperature range: -20 °C to +80 °C
- The elements are attached to the holes provided on the machine using the bolts supplied (see p. 46). Anchoring to the floor is usually not necessary.
- **Screw in the bolt by hand only, do not use an open-end wrench. Also only tighten the nut with low torque.**
- The machine is placed on the deflated element, which is then inflated in stages using the standard valve until dimension H (= working height) is reached. The maximum specified air pressure must also not be exceeded!
- **Inflation and deflation may only take place under load, observe the maximum permissible pressure.**
- Up to +/- 5 mm are available for levelling.

SETTLING BEHAVIOUR FAEBI®

Without adjustable damping (single chamber system)

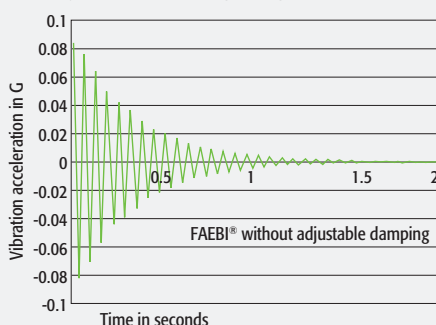

SETTLING BEHAVIOUR FAEBI®-HD

With adjustable damping (twin chamber system)

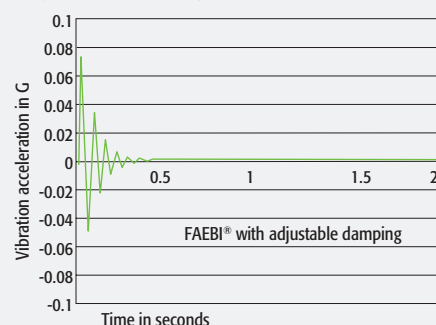

FAEBI®-HD

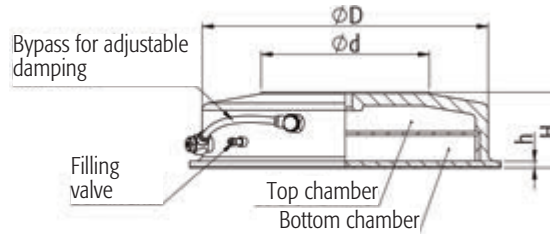
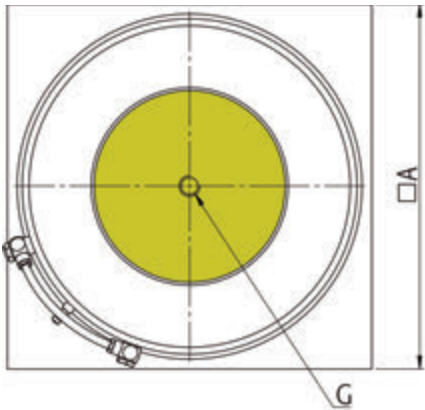

Type	Variant	Item no.	Load N/pc.	max. Pressure bar	A mm	Ø D mm	H approx. mm = Working height	H (deflated) mm	Ø d mm	h mm	G mm
FAEBI® 200-HD	Hart	40-0054	7.000 – 15.000	6	260	236	89	90	130	8	M16
	Standard	40-0053	6.250 – 15.000	6	260	236	89	90	130	8	M16
FAEBI® 300-HD	Hart	40-0063	14.000 – 29.500	6.5	370	340	89	94	200	8	M20
	Standard	40-0061	11.500 – 27.000	6	370	340	89	93	200	8	M20
FAEBI® 430-HD	Hart	40-0070	30.000 – 66.000	6.1	500	480	91	97	315	8	M20
	Standard	40-0067	27.500 – 65.000	6	500	480	91	96	315	8	M20
FAEBI® 580-HD	Super Hart	40-0081	60.000 – 115.000	6.9	680	650	126	135	380	14	M24
	Hart	40-0145	56.000 – 108.000	6.5	680	650	126	133	380	14	M24
	Standard	40-0080	47.000 – 100.000	6	680	650	126	130	380	14	M24



NATURAL FREQUENCIES FAEBI® 200-HD TO 580-HD

FAEBI® 200-HD

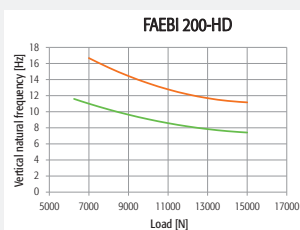

FAEBI® 300-HD

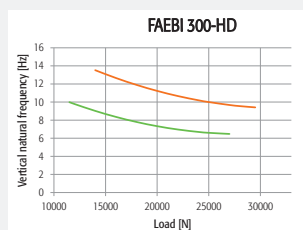

FAEBI® 430-HD

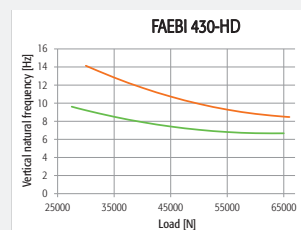

FAEBI® 580-HD

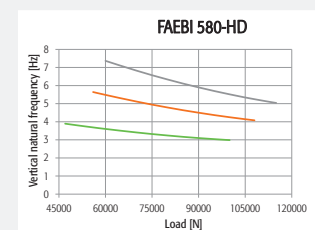

— Super Hart — Hart — Standard



FAEBI® AND FAEBI®-HD with mechanical-pneumatic level control (MPN-LCV)

The mechanical-pneumatic level control (MPN) with our robust proportional valve LVC represents a simple but effective solution for preventing skew positions resulting from load changes. A plunger continuously probes the level and the position of the plunger is transmitted to a slide valve. The air spring is either pressurized or the internal pressure is vented in accordance with the position of the plunger. The adjustable target level is maintained within an accuracy of $\pm 1/10$ mm. In principle three control valves are used, that optionally have an upstream air maintenance unit for conditioning the pneumatic air supply, limiting the system pressure to 6 bar, removing accumulated condensate and filtering out solid particles (rust and dust). For further details see the catalogue page 52.

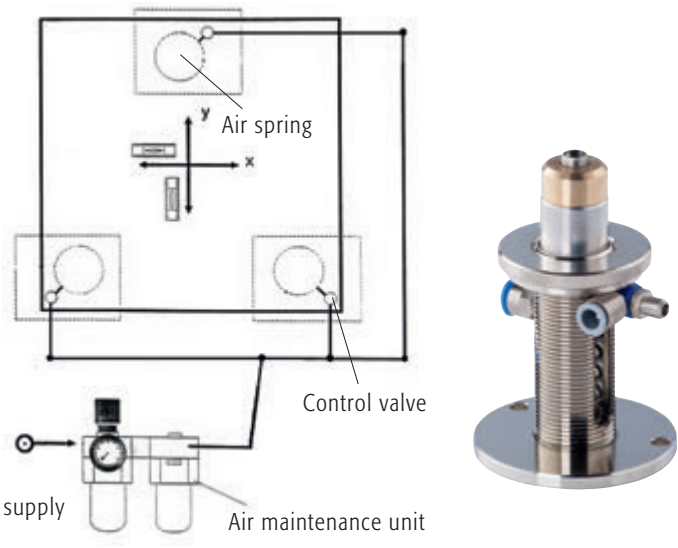

PRESSURE CONTROL FOR FAEBI® AND FAEBI®-HD



The Bilz pressure control is the ideal addition to applications that does not need automatic level control.

Instead of filling the air springs manually, they are connected to a constant compressed air supply. The working height of the individual insulators can each be individually set with one pressure regulator.

Applications

- Applications with a constant centre of gravity during the production/testing process (no moving machine components, workpieces, etc., steady masses).
- Difficult to access systems, where the manual checking of air pressure in the air springs is impeded.

Advantages of FAEBI® pressure control

- Simple and precise setting of the required pressure for each air spring or control group.
- Maintenance free
- Manometer for continuous pressure indication
- Upstream particle filter and water trap
- Can be configured for any number of air springs or control groups

PROTECTIVE HOOD FOR FAEBI® AND FAEBI®-HD ELEMENTS

If the contact surface of the FAEBI® element (see Type series FAEBI® or FAEBI®-HD) is not completely covered by the bottom edge of the machine, then an appropriate hood is required to ensure the sufficient load distribution across the air spring. A hood will also provide protection from external damage.

Material: Steel sheet (primed black)

The protective hood is also available in stainless steel on request.

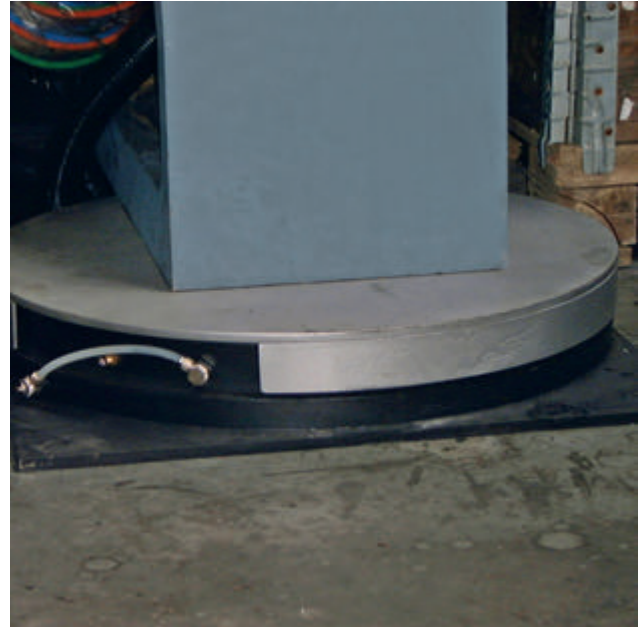
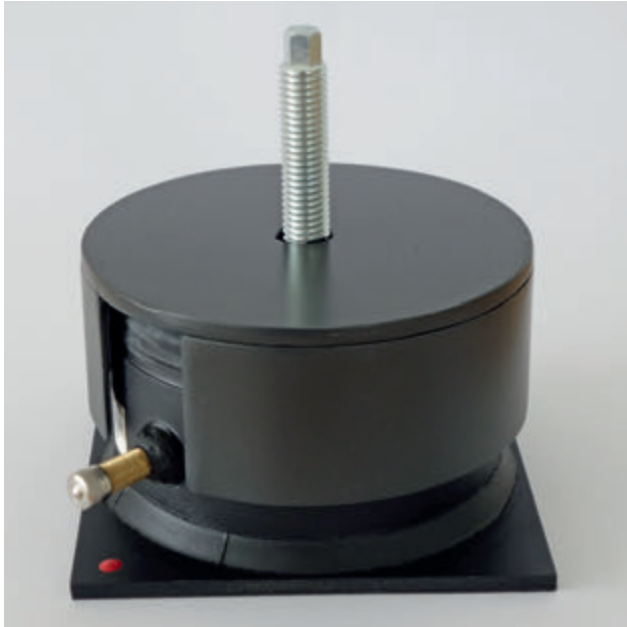

Type	Item no.	A (mm)	D (mm)	s (mm)	h (mm)	d (mm)
AH- FAEBI® 50/75	40-0013	13	115	5	40	2
AH- FAEBI® 100	40-0001	14	140	5	45	2
AH- FAEBI® 125	40-0003	18	160	5	60	2
AH- FAEBI® 150	40-0006	18	190	5	60	2
AH- FAEBI® 200/-HD	40-0007	18	255	5	60	3
AH- FAEBI® 300/-HD	40-0009	22	360	5	60	3
AH- FAEBI® 430/-HD	40-0011	22	500	10	60	4
AH- FAEBI® 580/-HD	40-0014	27	680	10	60	4

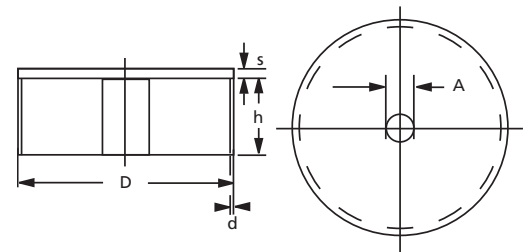

FIXING BOLTS FOR FAEBI® AND FAEBI®-HD

A large range of different bolts are available for each type of FAEBI® element. The suitable bolt in each case can be found in the adjacent table.

All bolts are delivered with standard thread.

1 bolt, 1 nut and 1 washer are supplied with the FAEBI® elements.

Note

Do you need a type of bolt that is not listed in the table? Please contact us. We are happy to offer a wide selection of low-cost special bolts in terms of size, thread, material, quality, etc.

FAEBI®(-HD) TYPE	Thread	Material	Item No.	Length mm
FAEBI®50	M10	galvanised	19-0019	100
	M10	stainless steel	18-0005	100
FAEBI®75/100	M12	galvanised	19-0041	100
	M12	stainless steel	18-0016	100
FAEBI®125/150/ 200(-HD)	M16	galvanised	19-0091	125
	M16	stainless steel	18-0066	125
FAEBI®300(-HD)/ 430(-HD)	M20	galvanised	19-0185	150
	M20	stainless steel	18-0044	150
FAEBI®580(-HD)	M24	galvanised	19-0214	150
	M24	stainless steel	18-0052	150